

# KIT IVECO DAILY H2 F65

98655-733

FIAMMASTOR

- (DE) VERPACKUNGSGEHÄLT  
 (EN) PACKAGE CONTENTS  
 (FR) CONTENU DE L'EMBALLAGE  
 (ES) CONTENIDO DEL EMBALAJE  
 (IT) CONTENUTO DELL'IMBALLO

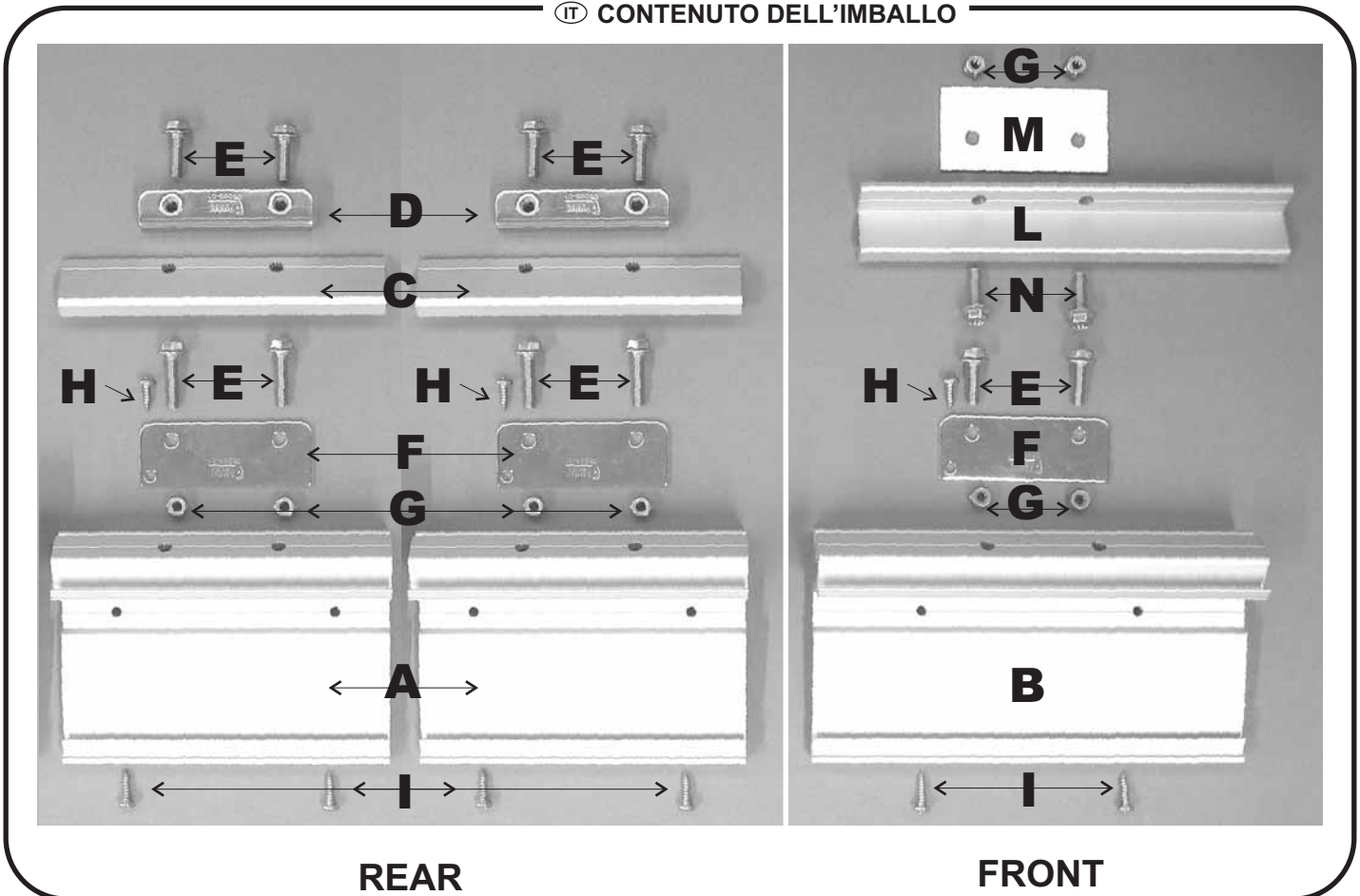

IVECO DAILY H2

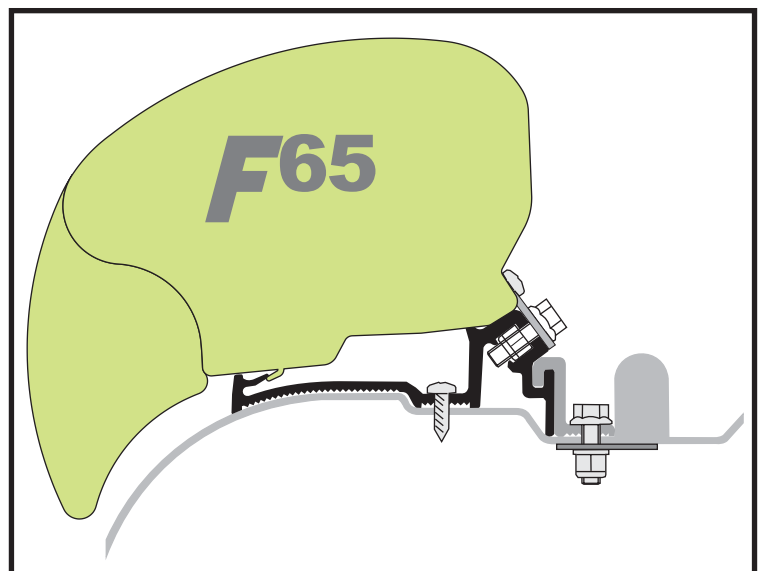

A1/IS/98690-033 rev. B

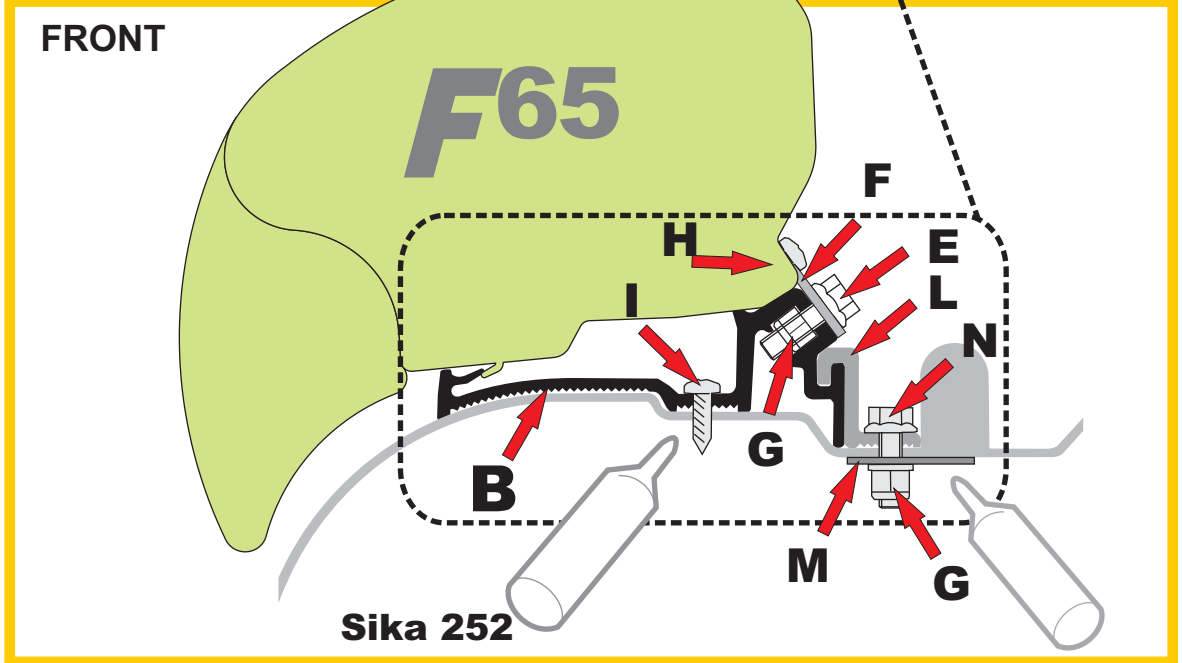
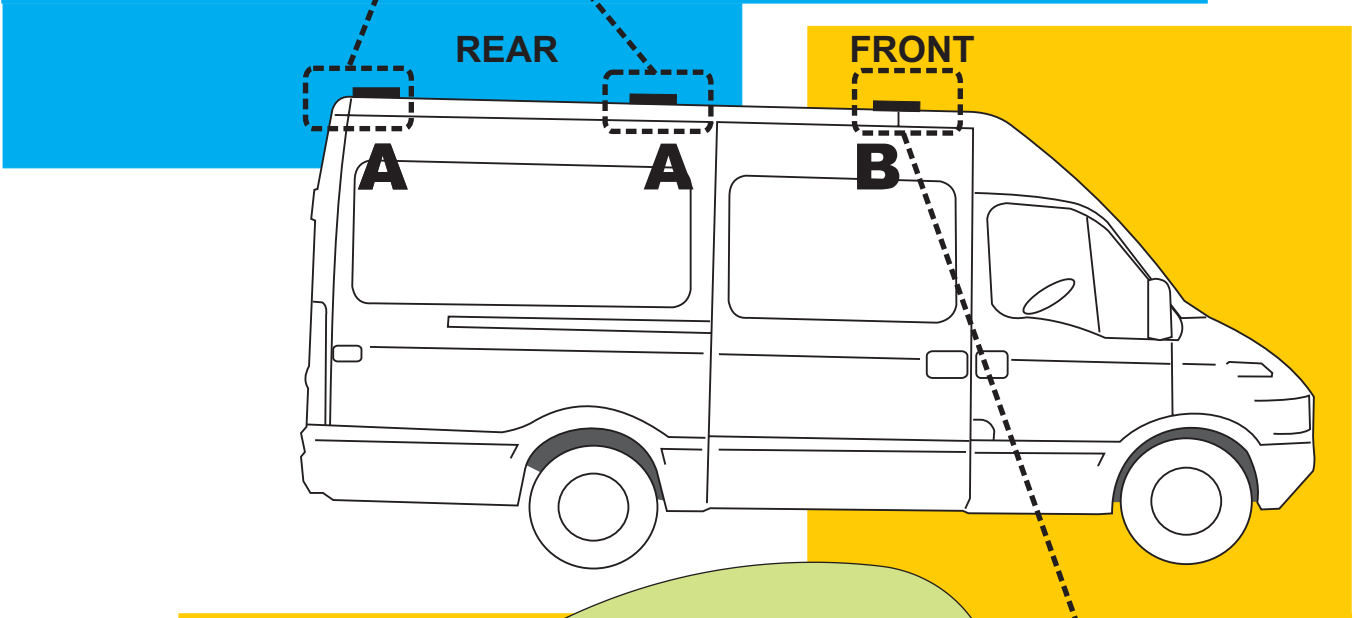
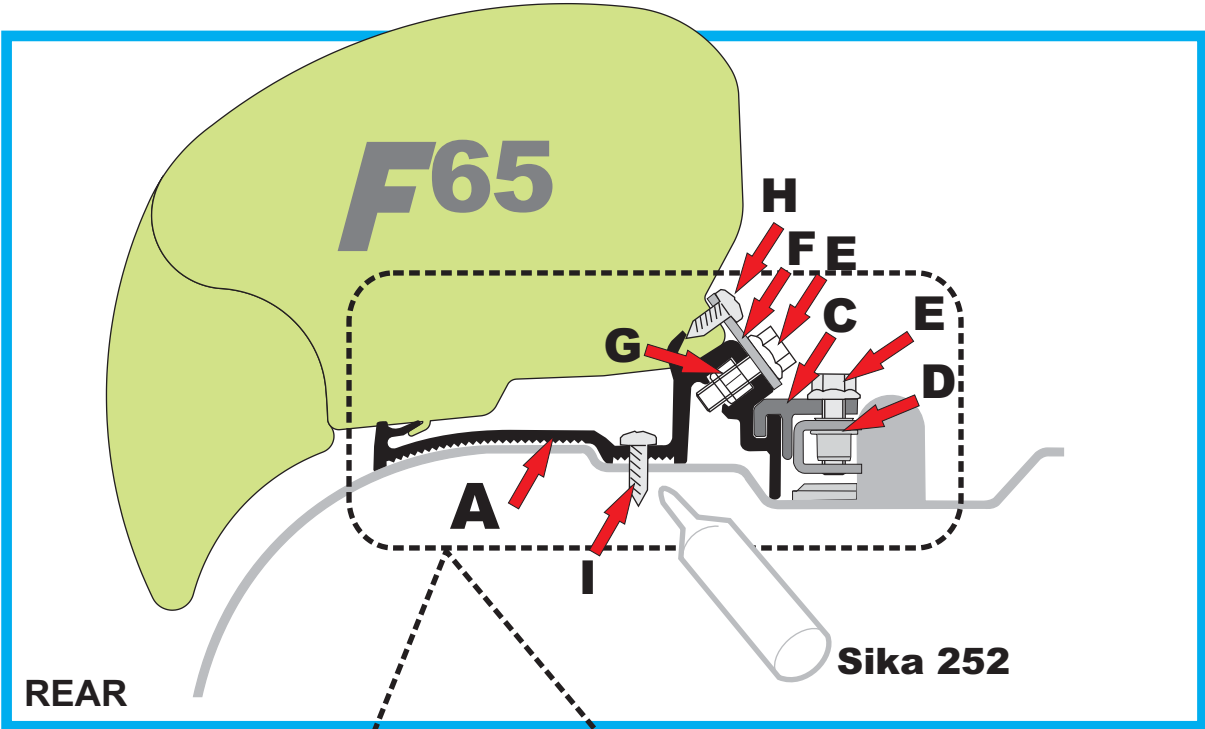

- ⓁⒹ Anbringung der Halterungen am Fahrzeug
- ⓁⒺ Installation of the brackets on the vehicle
- ⓁⒻ Installation des pattes sur le véhicule
- ⓁⒼ Instalación de los estribos sobre el vehículo
- ⓁⓉ Montaggio delle staffe sul mezzo

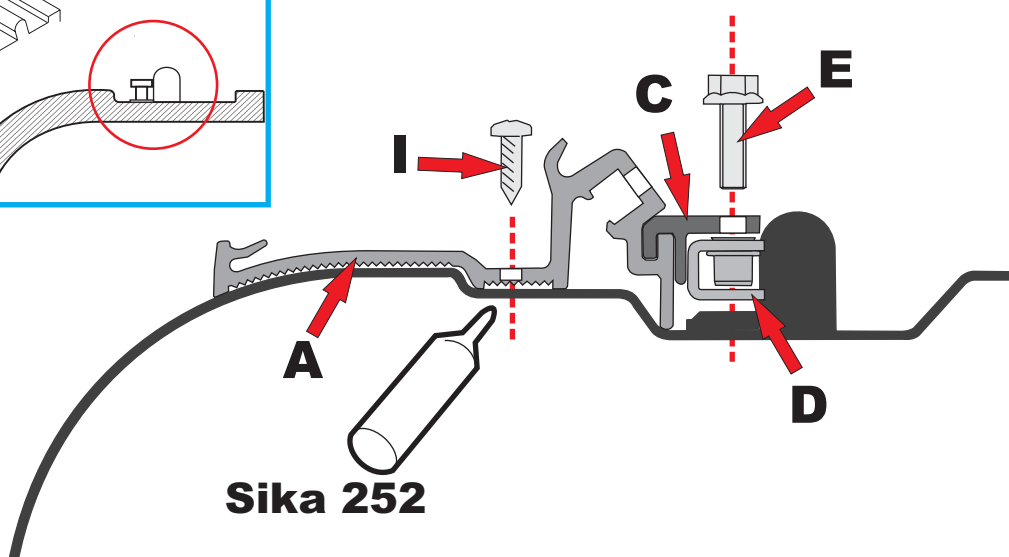
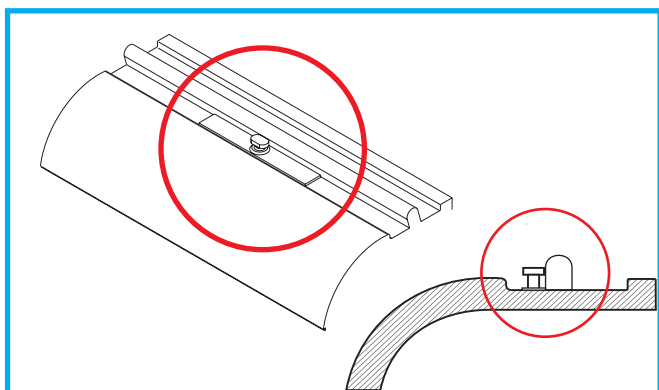
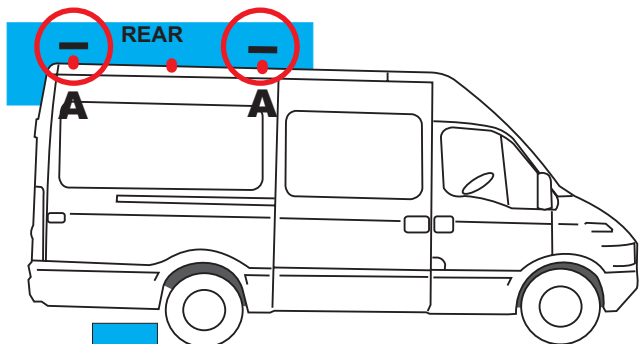

**Sika 252**

- ⓁⒹ Positionieren Sie die Halterungen an den schon am Fahrzeug vorhandenen Anbringungspunkten. Versichern Sie sich, dass sich die Halterungen entsprechend der Beschriftung "SUPPORT" des Markisengehäuses und folglich entsprechend den Anbringungspunkten der Arme an dem Gehäuse befinden.
- ⓁⒺ Fit the brackets on the already fixing points on the vehicle and be sure they are in correspondence of the marks "SUPPORT" of the awning and consequently of the arms fixing points on the case box.
- ⓁⒻ Placer les pattes sur les points de fixation déjà prévus sur le véhicule, en s'assurant qu'elles se trouvent bien en face du symbole "SUPPORT" du store et par la suite en face du point d'attache des bras sur le boîtier.
- ⓁⒼ Colocar los estribos sobre los puntos de fijación ya predispuestos sobre el vehículo, asegurándose que se encuentren a nivel de las escritas "SUPPORT" de los toldos y consiguientemente a nivel de los puntos de fijación de los brazos sobre el contenedor.
- ⓁⓉ Posizionare le staffe sui punti di fissaggio già predisposti sul mezzo, assicurandosi che si trovino poi in corrispondenza delle scritte "SUPPORT" dei tendalini e conseguentemente in corrispondenza al punto di fissaggio delle braccia sul cassonetto.

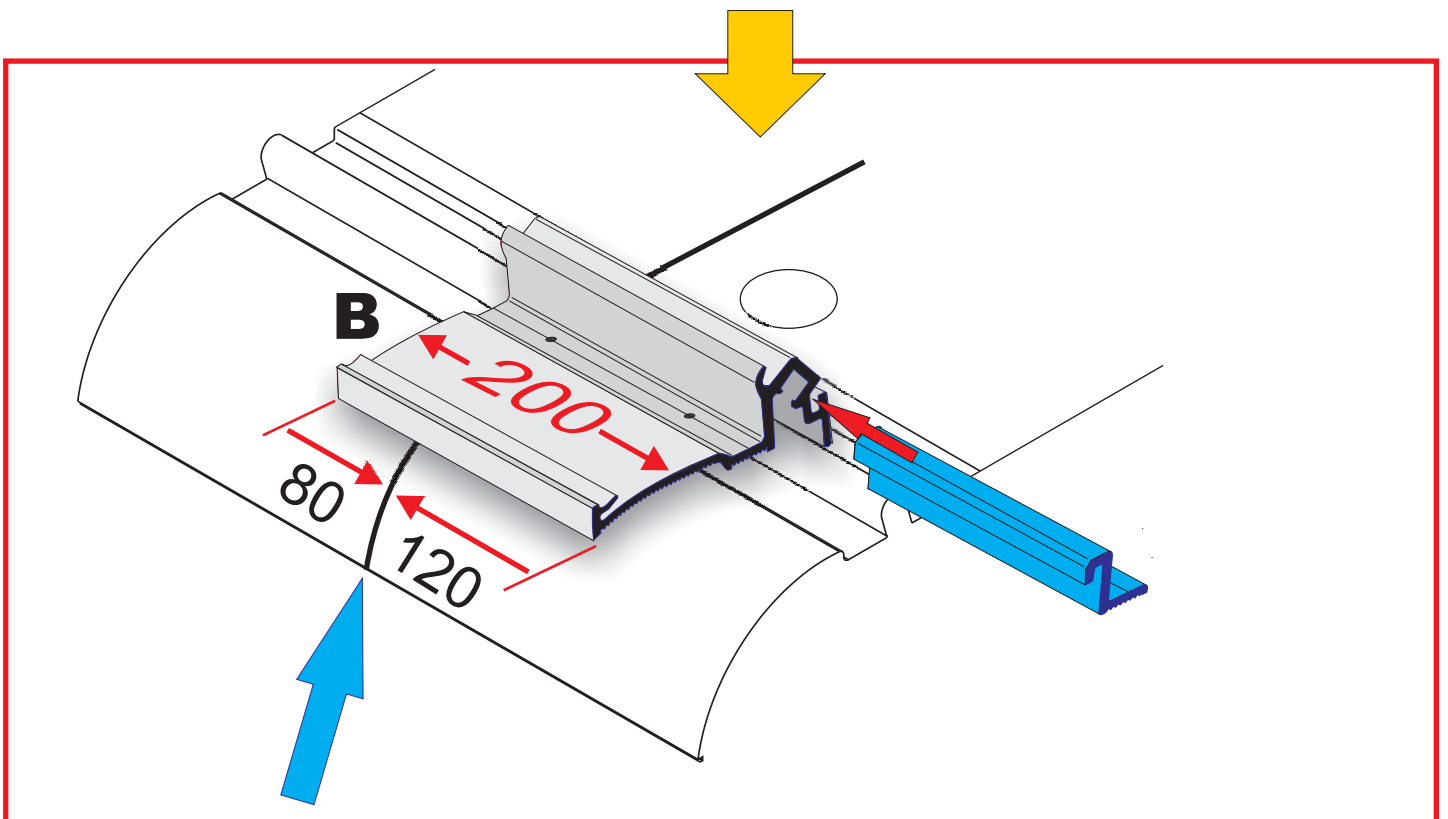
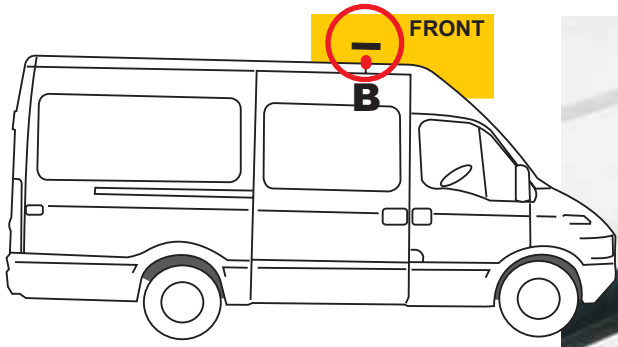

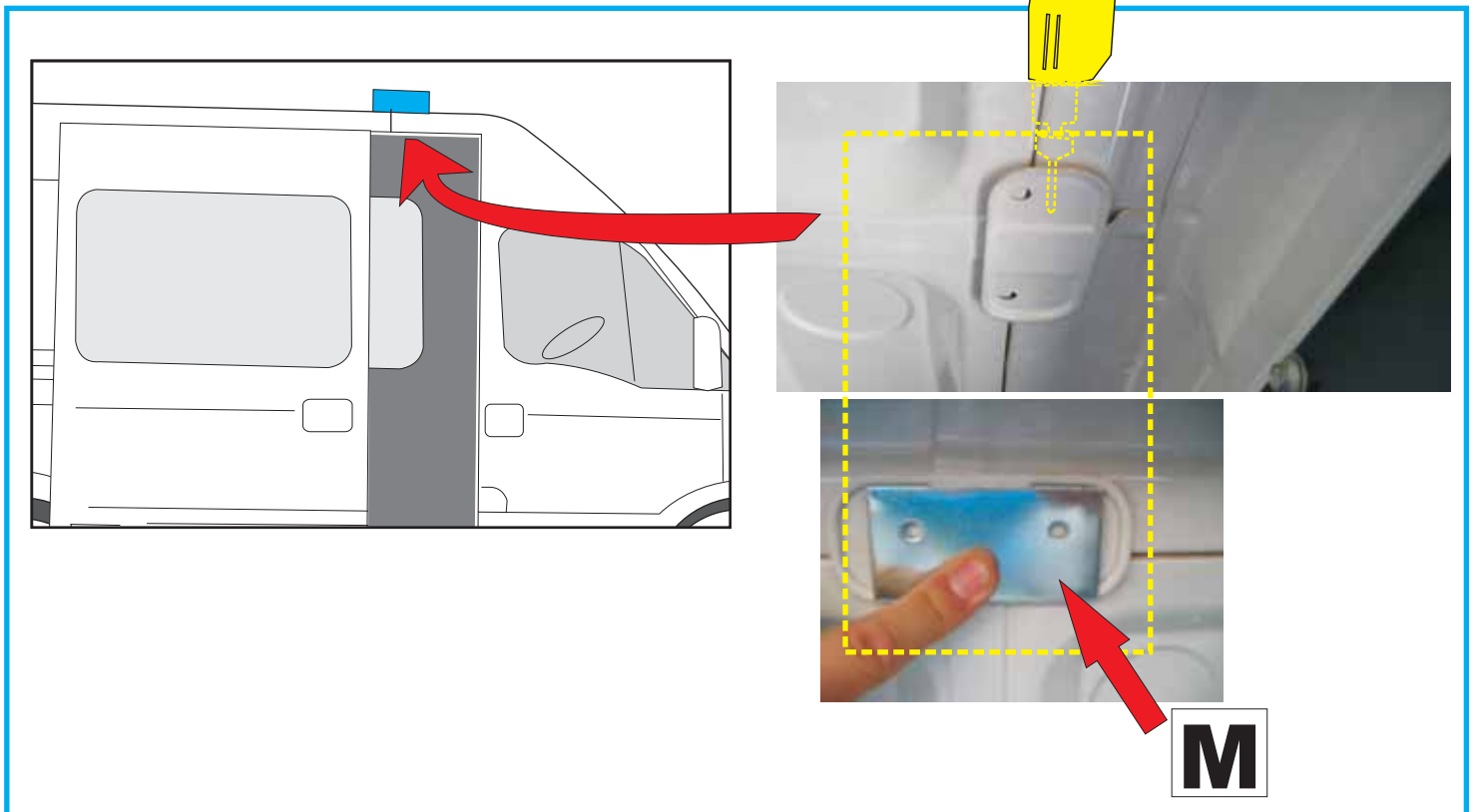
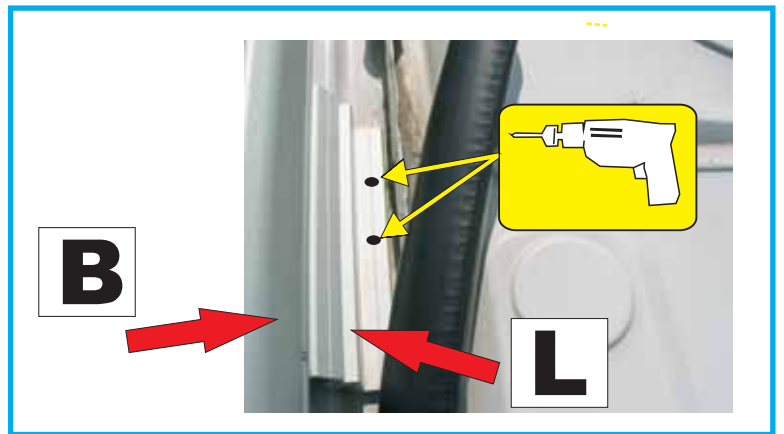
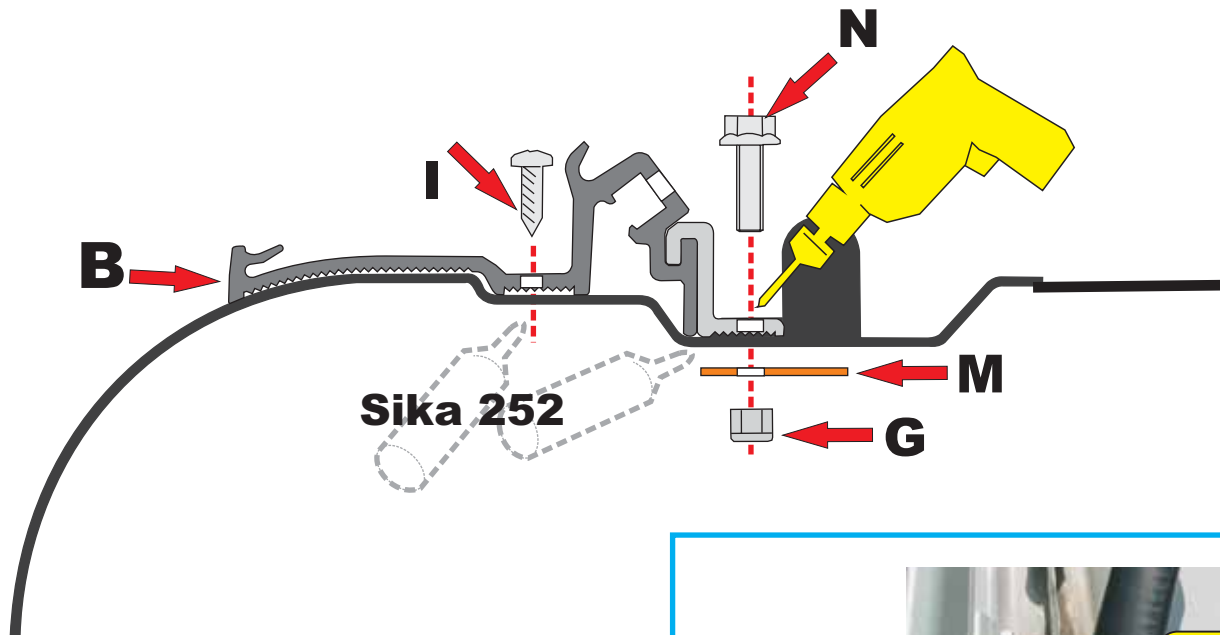

- DE Anbringung der Markise auf die Halterungen
- EN Installation of the awning on the brackets
- FR Installation du store sur les pattes
- ES Fijación del toldo sobre los estribos
- IT Montaggio del tendalino sulle staffe

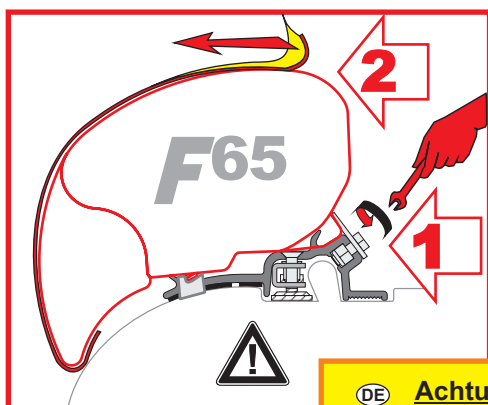
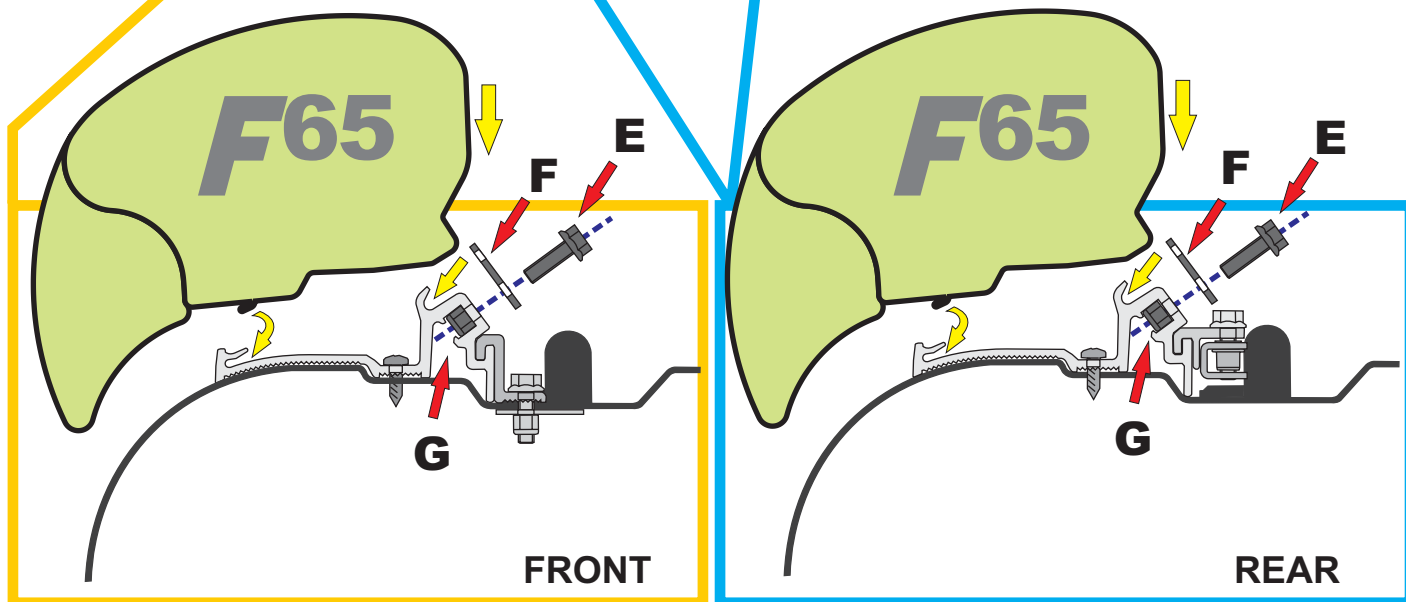
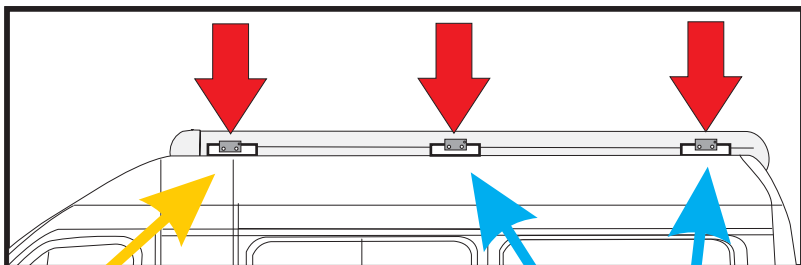
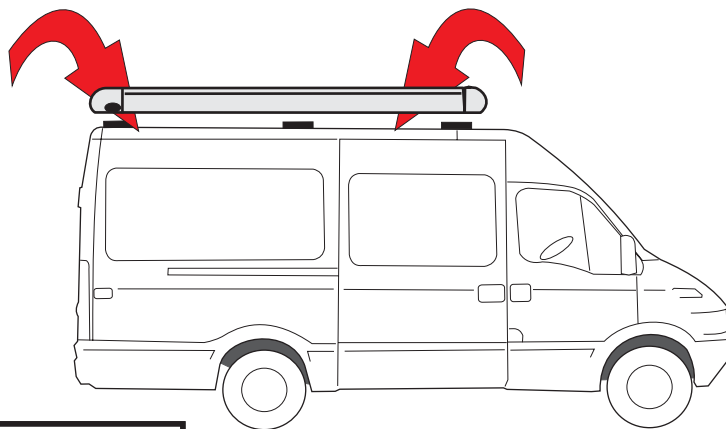

DE **Achtung Sicherheit**

Entfernen Sie die Etikette nur nachdem die Markise mit der Halterung befestigt wird.

EN **Attention Security**

Remove this label only after fixing the awning on the bracket.

FR **Attention Sécurité**

Lever l'étiquette seulement après la fixation du store à L'étrier.

ES **Atención-Seguridad**

Quitar esta etiqueta de seguridad solo después de fijar el toldo sobre el estribo.

IT **Attenzione Sicurezza**

Rimuovere questa etichetta di sicurezza solo dopo aver fissato il tendalino sulla staffa.



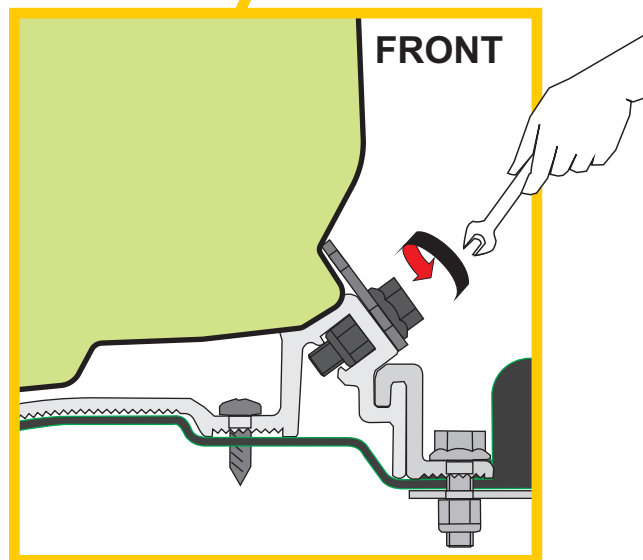
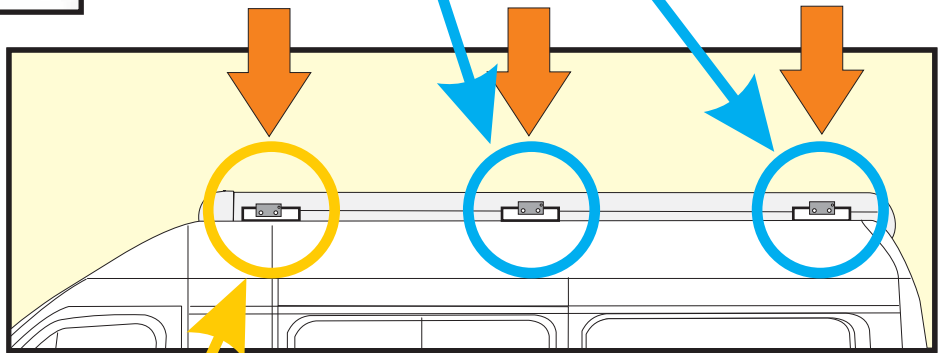
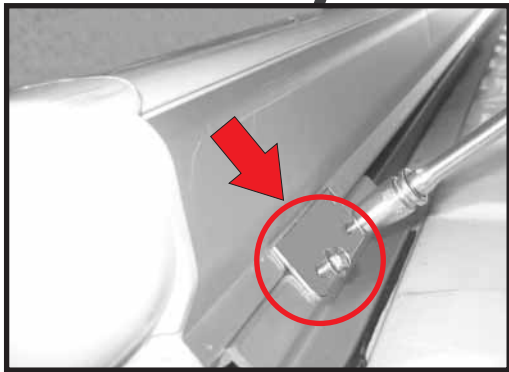
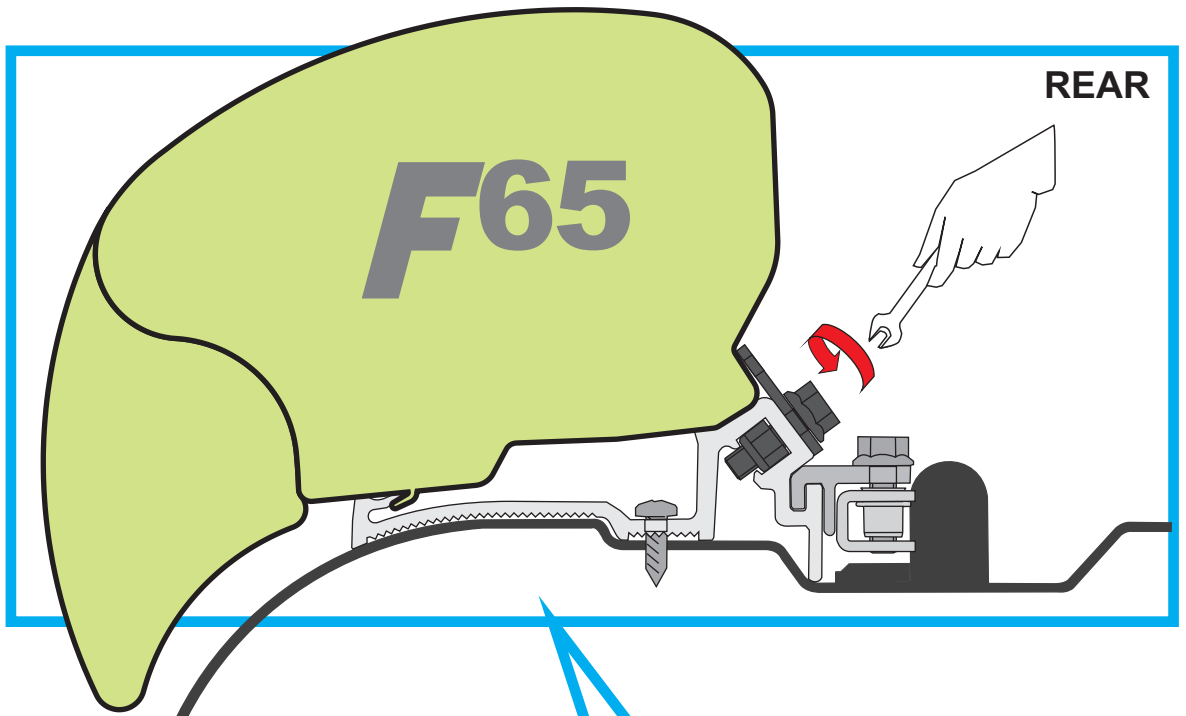

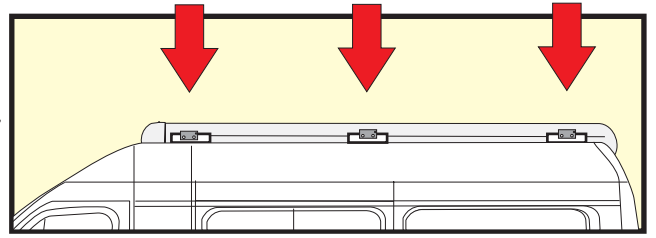
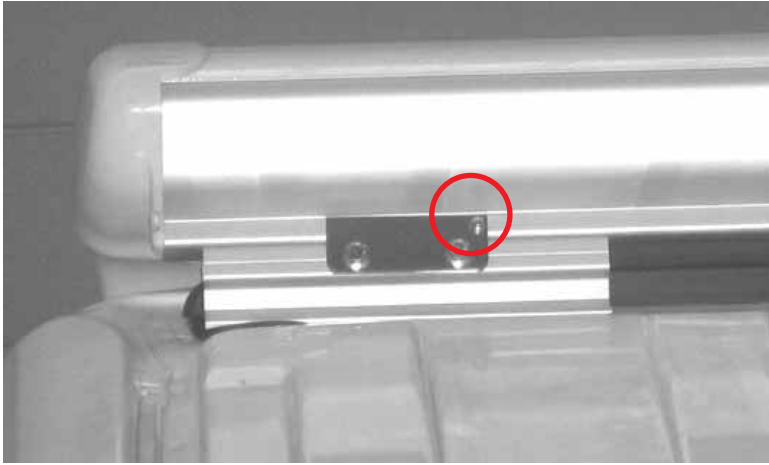

- Ⓓ **Bitte immer die Sicherheitsschrauben benützen.**
- Ⓔ **Please use always the security screw.**
- Ⓕ **Utilisez toujours les vis de sécurité.**
- Ⓔ **Poner siempre los tornillos de Seguridad.**
- Ⓙ **Mettere sempre le viti di sicurezza.**

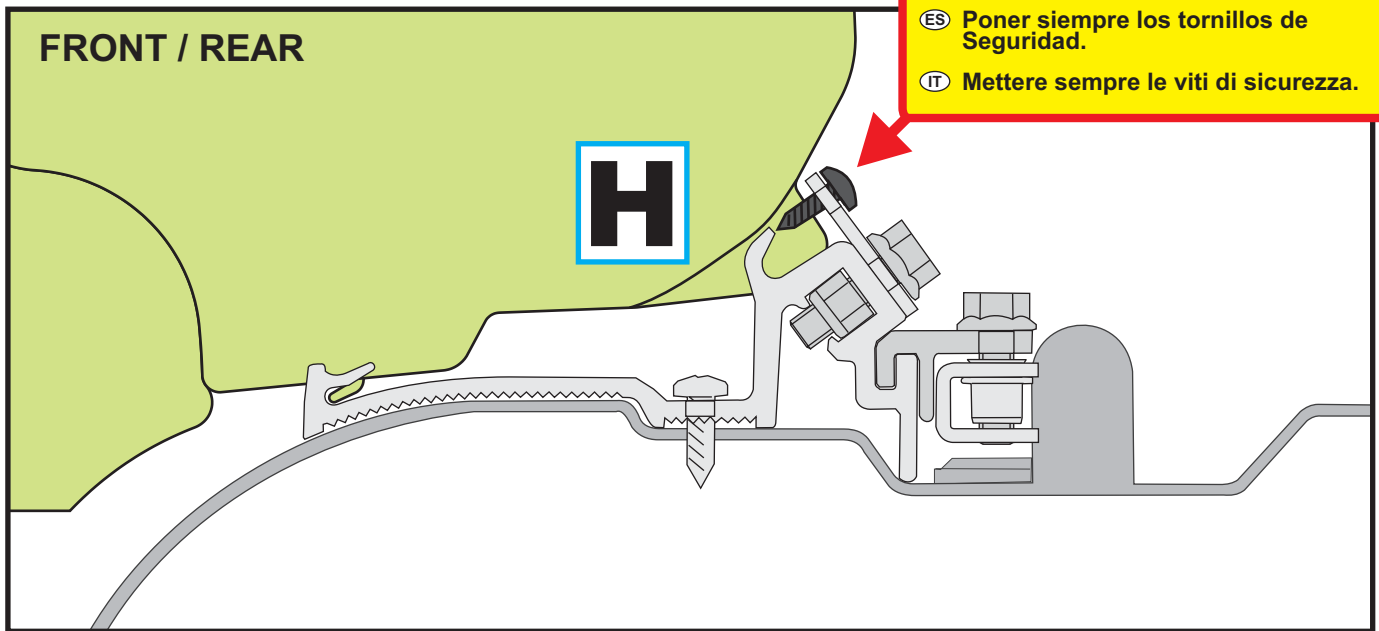

- Ⓓ **ACHTUNG** Regelmäßig die Befestigung der Halterungen kontrollieren. Achten Sie vor allem nach dem ersten Sicherstellen darauf, dass sich die Haltebügel nicht verschoben haben.
- Ⓔ **ATTENTION** Periodically check the brackets to make sure it is firmly attached (especially after the first kilometers) make sure the belts are not loose and that holding brackets have not shifted.
- Ⓕ **ATTENTION** Contrôler périodiquement l'état de fixation des pattes (surtout après les premiers kilomètres) en s'assurant que les supports de fixation n'aient pas bougé.
- Ⓔ **CUIDADO** Controlar periodicamente el estado de fijación de los estribos (sobretudo después de los primeros Kms) asegurándose que no se desplacen.
- Ⓙ **ATTENZIONE** Controllare periodicamente lo stato di fissaggio delle staffe (soprattutto dopo i primi chilometri) assicurandosi che le stesse non si siano mosse e che i serraggi siano corretti.



- Ⓓ **Bitte halten Sie sich beim Gebrauch der Markise an die Gebrauchsanweisung.**
- Ⓔ **When using the awning please follow the instructions of the product.**
- Ⓕ **Pour l'utilisation du store, se référer aux instructions du store même.**
- Ⓔ **Para el uso del toldo, atenerse a las instrucciones que se encuentran en el producto.**
- Ⓙ **Per l'utilizzo del tendalino, attenersi alle istruzioni presenti nel prodotto.**

